

Network Video Recorders

Quick Guide

Manual Version: V1.00

Thank you for purchasing our product. If there are any questions, or requests, please do not hesitate to contact the dealer.

Copyright

Copyright 2015 Zhejiang Uniview Technologies Co., Ltd. All rights reserved. No part of this manual may be copied, reproduced, translated, or distributed in any form or by any means without prior consent in writing from our company.

Trademark Acknowledgement

 and other Uniview's trademarks and logos are the property of Zhejiang Uniview Technologies Co., Ltd. Other trademarks, company names and product names contained in this manual are the property of their respective owners.

Disclaimer



CAUTION!

The default password is used for your first login. To ensure account security, please change the password after your first login. You are recommended to set a strong password (no less than eight characters).

- To the maximum extent permitted by applicable law, the product described, with its hardware, software, firmware and documents, is provided on an "as is" basis.
- Best effort has been made to verify the integrity and correctness of the contents in this manual, but no statement, information, or recommendation in this manual shall constitute formal guarantee of any kind, expressed or implied. We shall not be held responsible for any technical or typographical errors in this manual. The

contents of this manual are subject to change without prior notice. Update will be added to the new version of this manual.

- Use of this manual and the product and the subsequent result shall be entirely on the user's own responsibility. In no event shall we be reliable to you for any special, consequential, incidental, or indirect damages, including, among others, damages for loss of business profits, business interruption, or loss of data or documentation, or product malfunction or information leakage caused by cyber attack, hacking or virus in connection with the use of this product.
- Video and audio surveillance can be regulated by laws that vary from country to country. Check the law in your local region before using this product for surveillance purposes. We shall not be held responsible for any consequences resulting from illegal operations of the device.
- The illustrations in this manual are for reference only and may vary depending on the version or model. The screenshots in this manual may have been customized to meet specific requirements and user preferences. As a result, some of the examples and functions featured may differ from those displayed on your monitor.
- This manual is a guide for multiple product models and so it is not intended for any specific product.
- Due to uncertainties such as physical environment, discrepancy may exist between the actual values and reference values provided in this manual. The ultimate right to interpretation resides in our company.



Environmental Protection

This product has been designed to comply with the requirements on environmental protection. For the proper storage, use and disposal of this product, national laws and regulations must be observed.



Safety and Compliance Information

Safety Symbols

The symbols in the following table may be found on installation-related equipment. Be aware of the situations indicated and take necessary safety precautions during equipment installation and maintenance.

Symbol	Description
	Generic alarm symbol: To suggest a general safety concern.
	ESD protection symbol: To suggest electrostatic-sensitive equipment.
	Electric shock symbol: To suggest a danger of high voltage.

The symbols in the following table may be found in this manual. Carefully follow the instructions indicated by the symbols to avoid hazardous situations and use the product properly.

Symbol	Description
 WARNING!	Indicates a hazardous situation which, if not avoided, could result in bodily injury or death.
 CAUTION!	Indicates a situation which, if not avoided, could result in damage, data loss or malfunction to product.
 NOTE!	Indicates useful or supplemental information about the use of product.

Safety Information

Installation and removal of the unit and its accessories must be carried out by qualified personnel. Please read all of the safety instructions below before installation and operation.

- This device is a class A product and may cause radio interference. Take measures if necessary.
- While shipping, the device should be packed in its original packing.
- Verify that installation is correct. Incorrect cable connection may cause personal injury or device damage.
- The installation must be made by qualified personnel and should conform to all the local codes.
- If the product does not work properly, please contact your dealer. Never attempt to disassemble the device yourself. We shall not assume any responsibility for problems caused by unauthorized repair or maintenance.
- Ensure a proper operating environment, including temperature, humidity, ventilation and power supply. Make sure the device is properly grounded and the lightning protection meets requirements. Keep the device from moisture, dust, strong electromagnetic radiation and vibration.
- Power down the device before connecting and disconnecting accessories and peripherals.
- Protect the power cable from being stepped on or pressed, particularly at the plug, receptacle, and the part leading out of the device.
- Strictly follow the procedure to shut down the device. Sudden power failures can cause disk damage and functional abnormalities. In an environment where power supply is frequently interrupted, use an Uninterrupted Power Supply (UPS).
- Improper use or replacement of the battery may result in hazard of explosion. Use the manufacturer recommended battery.
- Take necessary measures to ensure data security and protect the device from network attack and hacking (when connected to Internet). Possible risks and consequences are at user's sole discretion.



WARNING!



- Never look at the transmit laser while the power is on. Never look directly at the fiber ports and the fiber cable ends when they are powered on.
 - Use of controls or adjustments to the performance or procedures other than those specified herein may result in hazardous laser emissions.
-

Regulatory Compliance

FCC Part 15

This equipment has been tested and found to comply with the limits for digital device, pursuant to part 15 of the FCC Rules. These limits are designed to provide reasonable protection against harmful interference when the equipment is operated in a commercial environment. This equipment generates, uses, and can radiate radio frequency energy and, if not installed and used in accordance with the instruction manual, may cause harmful interference to radio communications. Operation of this equipment in a residential area is likely to cause harmful interference in which case the user will be required to correct the interference at his own expense.

This product complies with Part 15 of the FCC Rules. Operation is subject to the following two conditions:

1. This device may not cause harmful interference.
2. This device must accept any interference received, including interference that may cause undesired operation.

LVD/EMC Directive



This product complies with the European Low Voltage Directive 2006/95/EC and EMC Directive 2004/108/EC.

WEEE Directive–2002/96/EC



The product this manual refers to is covered by the Waste Electrical & Electronic Equipment (WEEE) Directive and must be disposed of in a responsible manner.

Contents

1 Installation	1
Hard Disk Installation	1
Installation Without a Mounting Plate	1
Installation with a Mounting Plate	4
Mounting the NVR	7
2 Appearance and Connection	8
Front Panel	9
Rear Panel	13
Connection	16
3 Startup and Shutdown	16
Before Startup	16
Startup	16
Shutdown	17
4 Setup	17
Wizard	17
Adding an IP Device	18
Preview	18
Preview Window Toolbar	18
Preview Status Icons	19
Shortcut Menu	20
Scheduled Recording	21
Playback	22
Accessing Through the Web	22
5 FAQs	23
6 Technical Specifications	23

1 Installation

The figures in this manual are for reference only and may be different from the actual device.

You need a Phillips screwdriver (#1 or #2) to complete the installation.

Hard Disk Installation



CAUTION!

Disconnect power from the device before you start installation. Wear antistatic gloves during installation.

Installation Without a Mounting Plate

This section is intended for NVRs with one or two disks. The following takes an NVR with two disks as an example.

1. Loosen the screws on the rear panel and remove the cover.



2. Insert the screws and tighten the screws halfway.



3. Connect the data cable to the hard disk.



4. Connect the power cable to the hard disk.

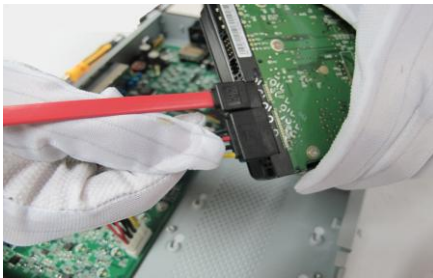

5. Align the screws on the hard disk with the screw holes on the bottom plate and then attach the hard disk.



6. Slide the hard disk into position on the bottom plate as indicated in the figure below.

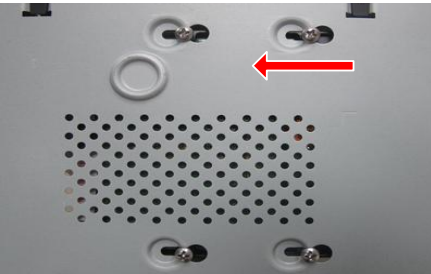

7. Secure the hard disk by fixing the screws on the bottom plate.

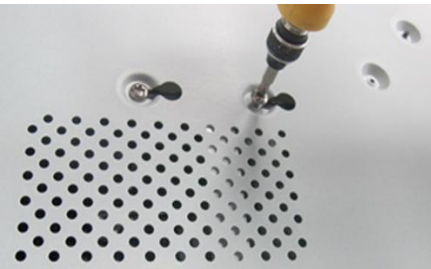

8. Connect data cables and power cables to the motherboard.



9. Repeat the above steps to install another disk.

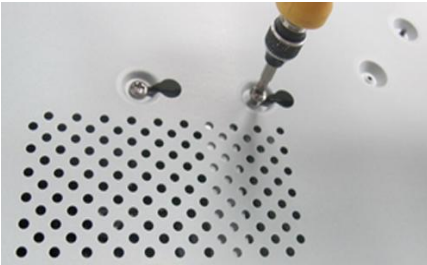

10. Replace the cover and fix the screws. Do not place cables on the hard disk(s).



Installation with a Mounting Plate

This section is intended for NVRs with four or eight disks. A mounting plate is delivered with the device.

The following takes an NVR with four disks as an example.

1. Loosen the two screws on the rear panel.



2. Remove the cover.



3. Remove the two screws that secure the hard disk mounting plate on both sides and then take out the mounting plate.



4. Install the hard disks one by one on the mounting plate.



5. Put the mounting plate back into the device and secure it.



6. Connect the hard disks and motherboard with data cables and power cables, and arrange the cables appropriately.



7. Replace the cover.



8. Fix the two screws on the rear panel.

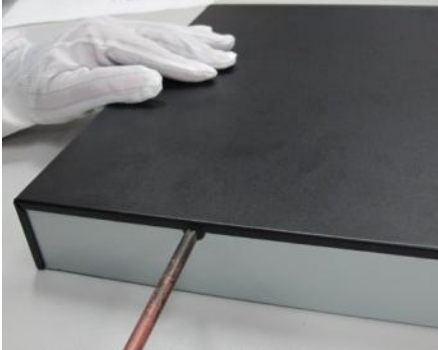

NOTE!

After removing the cover with the rear panel facing toward you, you see the disk data cable connectors (disks) arranged in the following order:

- Two disks:

Disk 2	Disk 1
--------	--------
 - Four or eight disks:

Disk 1	Disk 2	...	Disk N
--------	--------	-----	--------
-

Mounting the NVR

Allow at least 30 cm at the front and back sides and at least 10 cm at the left and right sides of the NVR for heat dissipation. If the NVR is mounted in a cabinet, allow at least one rack unit (RU) of space (1.75 inches or 4.45 cm) on top and bottom.

Workbench mount

Place the NVR on a clean and solid workbench. If protection pads are delivered with your NVR, use the protection pads to minimize vibration and improve heat dissipation.



CAUTION!

- Do not stack other devices on your NVR or put anything heavy on it. Otherwise, heat dissipation may be affected.
- Keep your NVR away from any vibration source; for example, an electric generator. Do not expose your NVR to direct strong airflow as from an air conditioner or electric fan.

Cabinet mount



NOTE!

Make sure the cabinet has slide rails or a tray installed to hold the NVR. Do not use only mounting ears to hold the NVR.

1. Attach a rack-mounting ear to the NVR and secure it with two M4×6 screws.
2. Install the other rack-mounting ear in the same way.



3. Place the NVR on the slide rails and then push it into place. Secure the rack-mounting ears to the cabinet with nuts and screws.

2 Appearance and Connection

The following figures are for reference only and may be different from the actual device.

Front Panel

Figure 2-1 NVR with 1 or 2 Disks



Figure 2-2 NVR with 4 Disks



Table 2-1 LED Indicators

LED	Color	Status	Description
RUN (Operation)	Blue	Steady on	The NVR is operating properly.
		Blinking	The NVR is starting up.
		Off	The NVR is shut down.
NET (Network)	Blue	Steady on	The NVR is connected to network.
		Off	The NVR is not connected to network.
HD (Hard disk)	Red	Steady on	No hard disk is installed; or at least one disk is in abnormal condition.
		Blinking	Data is being read or written.
		Off	The disk is in normal status but no data is being read or written; or the NVR is shut down.

Table 2-2 Front Panel Buttons







Button	Description
	Display the main menu.
	Switch to the next tab on the screen or switch the input method.
	Auxiliary function button.
	Exit the current window.
	<ul style="list-style-type: none"> ▲/▼/◀/▶: Switch windows or menu items; or control rotation directions of a PTZ camera when the PTZ toolbar is closed. ⏮/⏭: Rewind or forward 30 seconds in full screen mode. ⏪/⏩: Variable-speed forward or rewind.
	Confirm an operation; or start or pause the playback.
	When logged in, press and hold this button for around 3 seconds till a confirmation message appears on the monitor. Click Yes to shut down the NVR.

Figure 2-3 NVR with 8 Disks





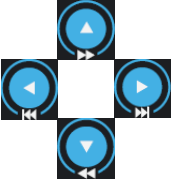

















Table 2-3 LED Indicators

LED	Color	Status	Description
PWR (Power)	Blue	Steady on	The power is normal.
		Off	The power is off.
RUN (Operation)	Blue	Steady on	The NVR is operating properly.
		Blinking	The NVR is starting up.
		Off	The NVR is shut down.
NET (Network)	Blue	Steady on	The NVR is connected to network.
		Off	The NVR is not connected to network.
GUARD (Arming)	Blue	Steady on	Arming is enabled.
		Off	Arming is disabled; or the NVR is shut down.
IR	Blue	Steady on	The NVR is selected and is ready for remote control.
		Blinking	Device code is being authenticated.
		Off	The NVR is not selected and cannot be controlled remotely.
HD (Hard disk)	Red	Steady on	No hard disk is installed; or at least one disk is in abnormal condition.

LED	Color	Status	Description
		Blinking	Data is being read or written.
		Off	The disk is in normal status but no data is being read or written; or the NVR is shut down.
ALM (Alarm)	Red	Steady on	An alarm has occurred.
		Off	The NVR is operating properly and no alarm has occurred.

Table 2-4 Front Panel Buttons

Button	Description
	When logged in, press and hold this button for around 3 seconds till a confirmation message appears on the monitor. Click Yes to shut down the NVR.
	Enter 1; or display the main menu.
	Enter 2, A, B, or C; or start instant playback.
	Enter 3, D, E, or F; or start manual recording.
	Enter 4, G, H, or I; or enter the PTZ control interface.
	Enter 5, J, K, or L; or switch the screen layout in preview or playback mode.
	Enter 6, M, N, or O; or enable or disable arming.
	Enter 7, P, Q, R, or S; or take a snapshot.
	Enter 8, T, U, or V.
	Enter 9, W, X, Y, or Z.

Button	Description
	Enter 0 or a space.
	Delete
	Switch the input method.
	Auxiliary function button.
	Exit the current window.
	Switch to the next tab.
	<ul style="list-style-type: none"> • : Switch windows or menu items; or control rotation direction of a PTZ camera when the PTZ toolbar is closed. • : Rewind or forward 30 seconds in full screen mode. • : Variable-speed forward or rewind. • : Confirm an operation, or start or pause playback.

Rear Panel

The interfaces on the rear panel may vary with device model. The following figures are for reference only and may be different from the actual device.

Figure 2-4 NVR with 1 or 2 Disks

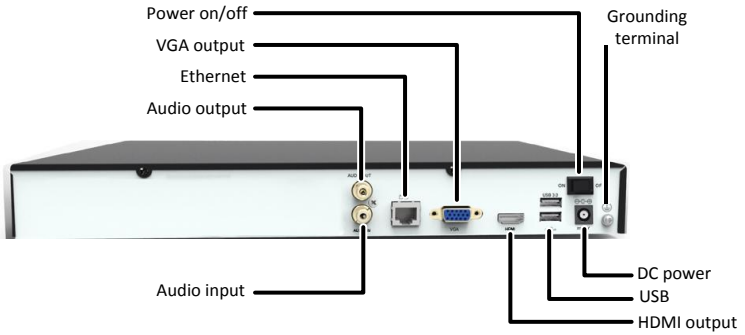

Figure 2-5 NVR with PoE Ports and 1 or 2 Disks

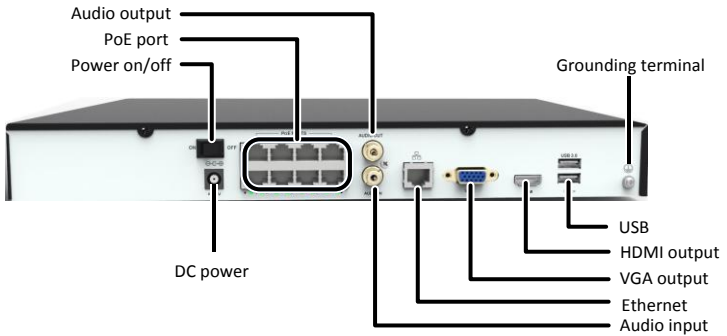

Figure 2-6 NVR with 4 Disks

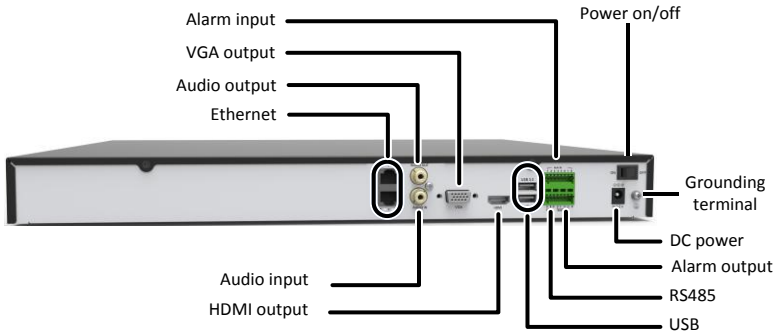
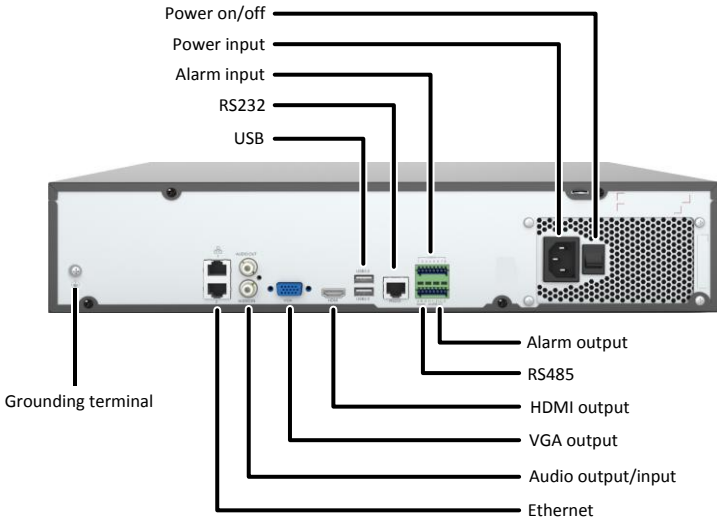

Figure 2-7 NVR with 8 Disks



NOTE!

The RS232 interface is for debugging and maintenance purposes. The Ethernet interface is for network connection. Please use these interfaces properly.

Connection

The following figure takes a model with PoE ports as an example. A PoE port can be used to transfer data and meanwhile provide DC power for a connected IP camera that also supports PoE.

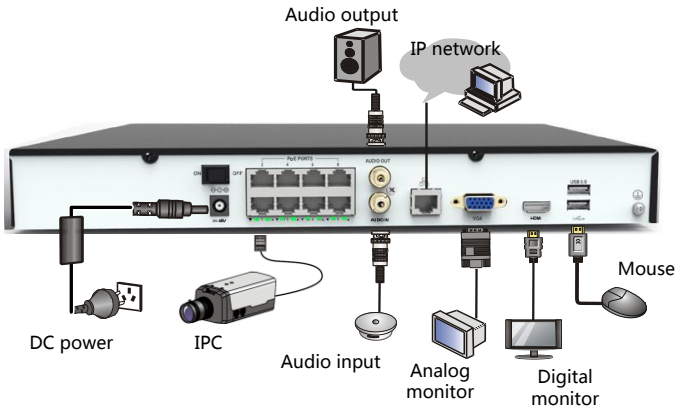

3 Startup and Shutdown

Before Startup

To avoid the risks of personal injury and device damage, make sure the following requirements are met before connecting your NVR to power:

- The NVR is properly mounted.
- Nothing is placed on the NVR.
- All cables are correctly connected.
- The power conforms to specifications.

Startup

Connect the NVR to power and then turn on the power switch.

Shutdown



CAUTION!

Do not disconnect power directly while the NVR is running or shutting down. A sudden power failure may damage the NVR.

Shut down by pressing the power button

Press and hold the power button on the front panel for at least three seconds till a confirmation message appears on the monitor. Click **Yes** to shut down the system.

Shut down through the system interface

Click **Menu > Shutdown > Shutdown** and then click **Yes** to confirm the operation.

4 Setup

Wizard

The wizard can guide you to complete the most basic configuration. After the NVR starts up, choose a system language and then follow the wizard to complete the setup.





CAUTION!







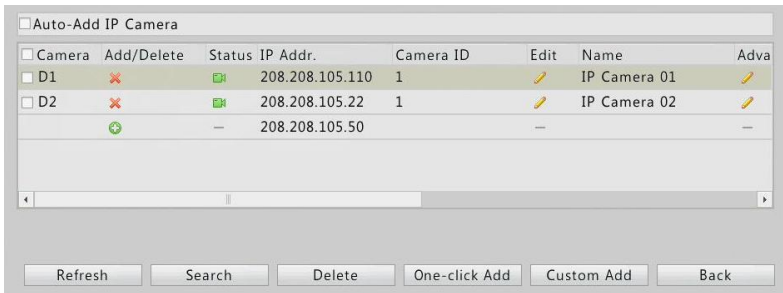

The default password 123456 is intended only for your first login. To ensure account security, please change the password immediately after login.

Adding an IP Device

Make sure the IP device is connected to your NVR through network.

1. Click **Menu > Camera > Camera**.
2. Click  for the desired IP device to add it.





<input type="checkbox"/>	Camera	Add/Delete	Status	IP Addr.	Camera ID	Edit	Name	Adva
<input checked="" type="checkbox"/>	D1			208.208.105.110	1		IP Camera 01	
<input type="checkbox"/>	D2			208.208.105.22	1		IP Camera 02	
<input type="checkbox"/>			—	208.208.105.50	—	—	—	—

Buttons: Refresh, Search, Delete, One-click Add, Custom Add, Back



NOTE!

- To search a specified network segment, click **Search**.
- Normally, all the IP devices discovered can be added, and  appears in the **Status** column to indicate that a device is added successfully. In the case of a failure, check network connection and verify that the username and password for the IP device are correct. To modify the username and password for an IP device, click  .













Preview

Preview Window Toolbar

A toolbar appears (see below) when you click in a preview window.







Table 4-1 Preview Window Toolbar Buttons

Button	Name	Description
	PTZ Control	Click to display the PTZ control panel for a PTZ camera.
	Manual Recording	Click to start recording live video to the NVR. The button turns into  when recording is started. To stop recording, click  .
	Instant Playback	Click to start playing the recording in the last 5 minutes and 30 seconds.
	Zoom	Click to zoom in on a certain area of the image.
	Image Config	Click to change the mode and adjust image settings. Image parameters can also be configured under Menu > Camera > Image .
	Manual Capture	Click to take a snapshot. To view or back up a snapshot, click Menu > Backup > Image .
	Camera Info	Place the mouse cursor on it for live video information.
	Start Talk	Click to start two-way audio with a remote device connected to the NVR. To stop, click  .
	Switch Camera	Click to link another camera to the current window.
	Exit	Click to quit the toolbar.

Preview Status Icons

The following icons are used to indicate alarms, recording status, and two-way audio status in a preview window.

Table 4-2 Preview Status Icon Description

Icon	Description	Icon	Description
	Tampering alarm		Recording
	Motion detection alarm		Two-way audio

Shortcut Menu

A shortcut menu appears (see figure in table below) when you right-click in a preview window.

Table 4-3 Shortcut Menu Description

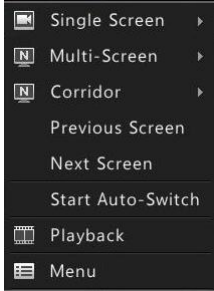
Menu	Description	Screenshot
Single Screen	Select the desired camera for live video in full screen.	
Multi-Screen	Select the desired screen layout.	
Corridor	Click to view video in corridor mode in a variety of windows.	
Previous Screen Next Screen	Switch to the previous or next screen.	
Start Auto-Switch Stop Auto-Switch	Start or stop auto-switching one or multiple preview windows.	
Playback	Display the playback window.	
Menu	Display the main menu.	

Scheduled Recording

1. Click **Menu > Storage > Recording**. Select the desired camera from the drop-down list, select **Enable Schedule**, and then click **Edit**.

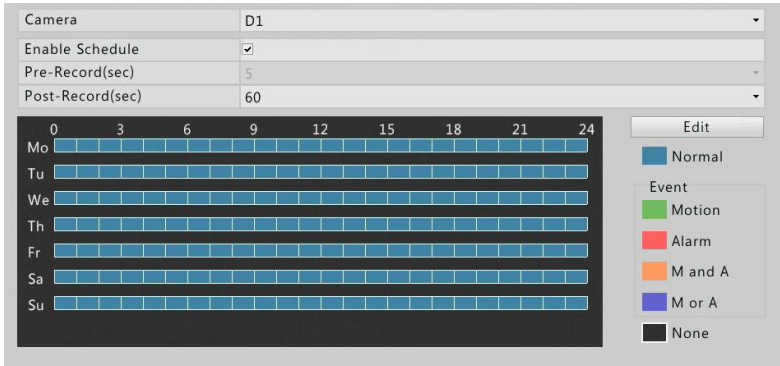

The screenshot shows a configuration window for recording settings. At the top, the 'Camera' is set to 'D1'. Below this, 'Enable Schedule' is checked. 'Pre-Record(sec)' is set to 5 and 'Post-Record(sec)' is set to 60. The main area is a 24-hour timeline grid for each day of the week (Mo to Su). The grid shows recording periods from 0 to 24 hours, all currently set to 'Normal' (blue). To the right of the grid is an 'Edit' button and a legend for recording types: Normal (blue), Motion (green), Alarm (red), M and A (orange), M or A (purple), and None (black).

2. Set recording period(s) and select a recording type. Review the settings and then click **OK**.



NOTE!

If you select a recording type under **Event**, you need to first enable the corresponding alarm function and configure alarm-triggered recording.

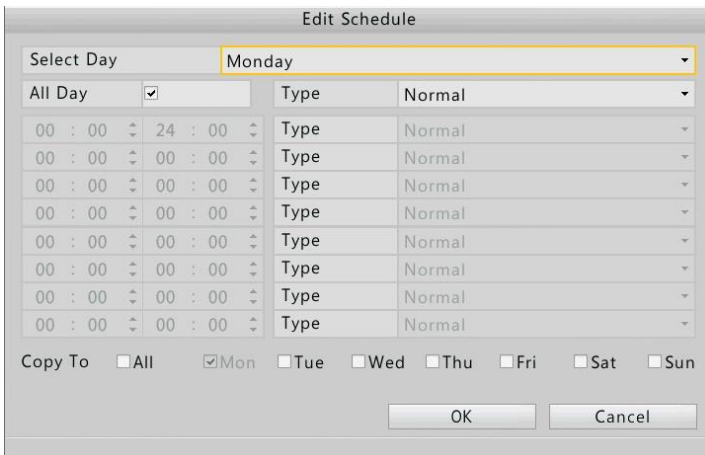

The screenshot shows the 'Edit Schedule' dialog box. The 'Select Day' dropdown is set to 'Monday'. Below this, there is a table with columns for 'All Day', 'Type', and 'Normal'. The 'All Day' checkbox is checked. The 'Type' dropdown is set to 'Normal'. Below the table, there are checkboxes for 'Copy To' for each day of the week: All, Mon (checked), Tue, Wed, Thu, Fri, Sat, Sun. At the bottom, there are 'OK' and 'Cancel' buttons.

3. Click **OK** to complete the configuration.

Playback

1. Right-click anywhere in the preview window and then choose **Playback** from the shortcut menu.
2. Select the desired camera and then double-click the desired date to start playback.



Accessing Through the Web

Check that your PC and NVR are connected through network.

1. Open a Web browser on your PC and visit the IP address of your NVR (192.168.0.30 by default). For your first login, you may need to install a plug-in as prompted. Close all Web browsers when the installation starts.
2. In the login dialog box, enter the correct username and password and then click **Login**. The default username is **admin** and password is **123456**.
3. Configure your NVR as required after you are logged in.



CAUTION!

The default password is intended only for your first login. To ensure account security, please change the password immediately after login.

5 FAQs

1. Why an added camera appears offline?

Log in to the Web interface of the NVR, click **Settings** > **Maintenance** > **Camera**, and you will find the cause in the **Status** column. Common causes include network connection issues and incorrect username and password for the camera. Act accordingly and then try again.

2. How to export diagnostic information from the NVR?

Log in to the Web interface, click **Settings** > **Maintenance** > **Maintenance**, click **Export** next to **Diagnostic Info**, and then follow the steps to download the diagnostic information.

6 Technical Specifications

Refer to the datasheets for more technical specifications.

Table 6-1 Specifications for NVR with 1 Hard Disk

Item	Description
Dimensions (W × D × H)	<ul style="list-style-type: none">• Height: 1U• 360.0 mm × 254.3 mm × 43.6 mm (with front panel) (14.2"×10.0"×1.7")
Weight (without disk)	< 1.5 kg (3.31 lb)
Power	<ul style="list-style-type: none">• Device without PoE ports: 12 V DC, < 2A• Device with PoE ports (4-ch): 48 V DC, < 1.25A• Device with PoE ports (8-ch): 52 V DC, < 1.8A

Item	Description
Maximum power consumption (with disk)	<ul style="list-style-type: none"> • Device without PoE ports: < 24W • Device with PoE ports (4-ch): < 60W • Device with PoE ports (8-ch): < 93.6W
Operating temperature	-10°C to +55°C (14°F to 131°F)
Operating humidity	10% to 90% (non-condensing)
Altitude	-60 m to +5000 m (-196.85 ft to 16,404.2 ft)

Table 6-2 Specifications for NVR with 2 Hard Disks

Item	Description
Dimensions (W × D × H)	<ul style="list-style-type: none"> • Height: 1U • 360.0 mm × 254.3 mm × 43.6 mm (with front panel) (14.2"×10.0"×1.7")
Weight (without disk)	<1.5 kg (3.31 lb)
Power	<ul style="list-style-type: none"> • PoE models: 52 V DC, <1.8 A • Other models: 12 V DC, <2 A
Maximum power consumption (with disks)	<ul style="list-style-type: none"> • PoE models: <93.6 W • Other models: <24 W
Operating temperature	-10 °C to +55 °C (14 °F to 131 °F)
Operating humidity	10% to 90% (non-condensing)
Altitude	-60 m to +5000 m (-196.85 ft to 16,404.2 ft)

Table 6-3 Specifications for NVR with 4 Hard Disks

Item	Description
Dimensions (W × D × H)	<ul style="list-style-type: none"> • Height: 1U • 440.0 mm × 341 mm × 44 mm (with front panel) (17.3"×13.43"×1.73")
Weight	<ul style="list-style-type: none"> • Without disk: <3 kg (6.6 lb) • With disks: <6 kg (13.2 lb)
Power	12 V DC, 5 A
Maximum power consumption	<ul style="list-style-type: none"> • Without disk: 6 W • With disks: 34 W
Operating temperature	-10 °C to +55 °C (14 °F to 131 °F)
Operating humidity	10% to 90% (non-condensing)
Altitude	-60 m to +5000 m (-196.85 ft to 16,404.2 ft)

Table 6-4 Specifications for NVR with 8 Hard Disks

Item	Description
Dimensions (W × D × H)	<ul style="list-style-type: none"> • Height: 2U • 442.0 mm × 421 mm × 86.1 mm (with front panel) (17.4"×16.57"×3.39")
Weight	<ul style="list-style-type: none"> • Without disk: <5.5 kg (12.13 lb) • With disks: <11 kg (24.25 lb)
Power	100V to 240V AC, with power switch
Maximum power consumption (without disk)	20 W
Operating temperature	-10 °C to +55 °C (14 °F to 131 °F)

Item	Description
Operating humidity	10% to 90% (non-condensing)
Altitude	-60 m to +5000 m (-196.85 ft to 16,404.2 ft)

BOM: 3101C0G6